

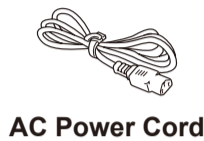

## Unpack the machine and check the components

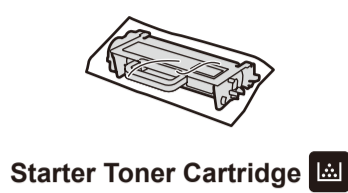
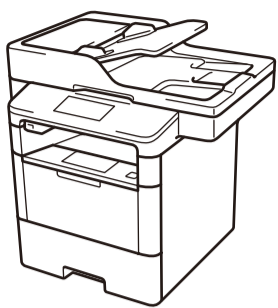

**NOTE:**

- Manuals in Spanish for this model are available on the Brother Solutions Center. (USA only): [solutions.brother.com/manuals](http://solutions.brother.com/manuals)  
Los manuales en español de este modelo están disponibles en el Brother Solutions Center. (Solamente en los Estados Unidos): [solutions.brother.com/manuals](http://solutions.brother.com/manuals)
- You must purchase the correct interface cable for the interface you want to use.

**USB cable**

We recommend using a USB 2.0 cable (Type A/B) that is no more than 6 feet (2 meters) long.

**Network cable**

Use a straight-through Category 5 (or greater) twisted-pair cable.

- The illustrations in this Quick Setup Guide show the MFC-L6900DW.



Watch our Video FAQs for help with setting up your Brother machine:  
[solutions.brother.com/videos](http://solutions.brother.com/videos).

## 1 Remove the packing materials and install the drum unit and toner cartridge assembly

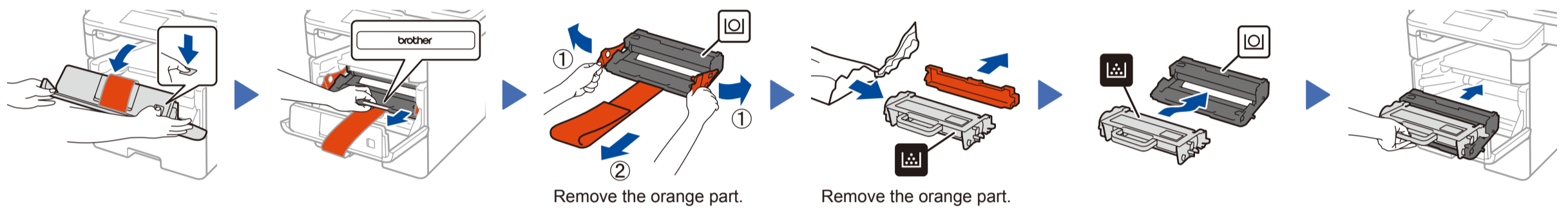

## 2 Load paper in the paper tray

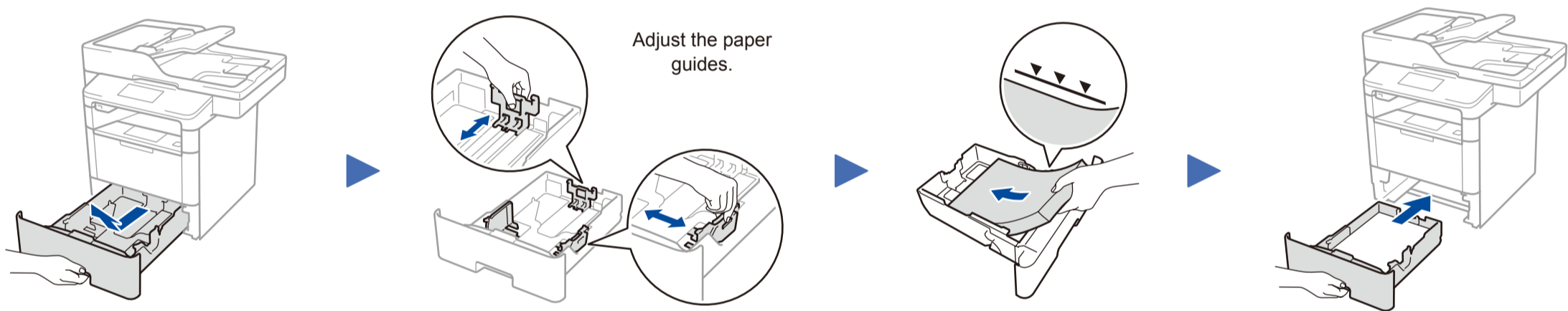

## 3 Connect the power cord and turn on the machine

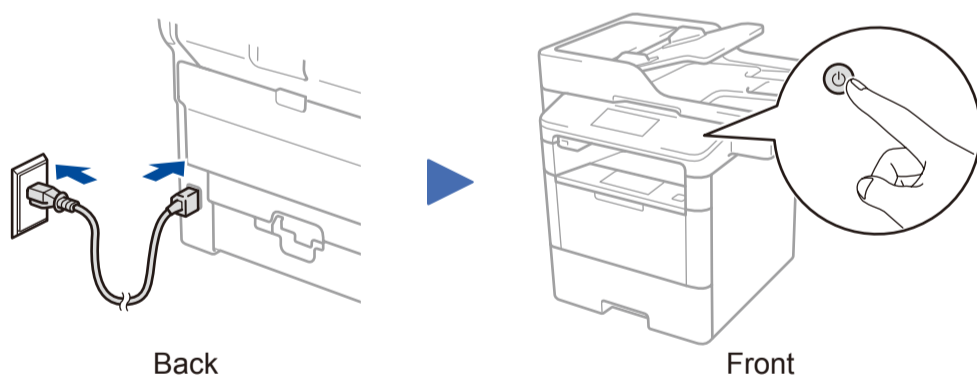

## 4 Connect the telephone line cord

If you do not plan to use the fax feature on this machine, go to step 5.

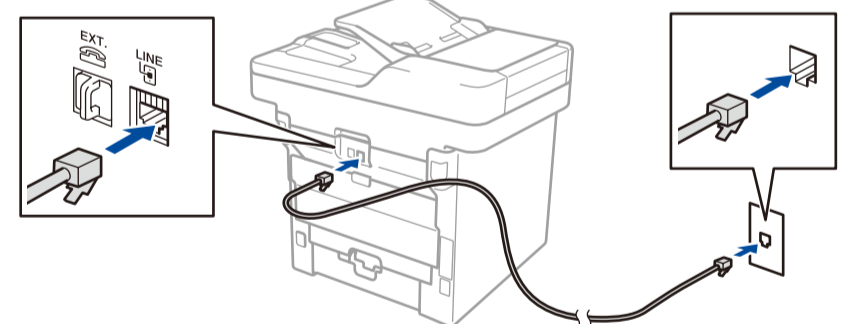

## 5 Select your language (if needed)

1. On the machine's Touchscreen, press [Settings] > [All Settings] > [Initial Setup] > [Local Language].
2. Press your language.
3. Press .

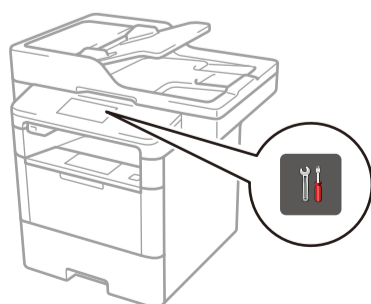

## 6 Configure the machine for faxing

If you do not plan to use the fax feature on this machine, go to step 7.

**NOTE:**

- For more information on using the fax feature, see the *Basic User's Guide*.
- Your machine is programmed to automatically receive faxes. To change this default mode, see the *Basic User's Guide*.

### A. Set the date and time

Press [Settings] > [All Settings] > [Initial Setup] > [Date & Time].

**Date**

1. Press [Date].
2. Enter the last two digits for the year using the Touchscreen, and then press [OK].
3. Enter the two digits for the month using the Touchscreen, and then press [OK].
4. Enter the two digits for the day using the Touchscreen, and then press [OK].

### Clock Type

1. Press [Clock Type].
2. Press [12h Clock] or [24h Clock].

**Time**

1. Press [Time].
2. Enter the time using the Touchscreen.
  - 12h Clock only  
Press [AM/PM] to select [AM] or [PM].
3. Press [OK].
4. Press .

### B. Set the Station ID

Press [Settings] > [All Settings] > [Initial Setup] > [Station ID].

**Fax number**

1. Press [Fax].
2. Enter your fax number (up to 20 digits) using the Touchscreen, and then press [OK].

**Telephone number**

1. Press [Tel].
2. Enter your telephone number (up to 20 digits) using the Touchscreen, and then press [OK].

**Name**

1. Press [Name].
2. Enter your name (up to 20 characters) using the Touchscreen, and then press [OK].
3. Press .

# 7 Connect your machine and install software

Brother regularly updates firmware to add features and fix identified problems. To check for the latest firmware, visit [solutions.brother.com/up1](http://solutions.brother.com/up1).

## Windows® computer with CD-ROM drive

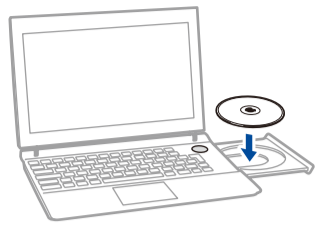

**NOTE:**  
If the Brother screen does not appear automatically, click **Start** > **Computer (My Computer)**. (For Windows® 8: click the **File Explorer** icon on the taskbar, and then go to **Computer (This PC)**.)  
Double-click the CD-ROM icon, and then double-click **start.exe**.

## Macintosh/Windows® computer without CD-ROM drive



Download the full driver and software package from the Brother Solutions Center.  
(Macintosh) [solutions.brother.com/mac](http://solutions.brother.com/mac)  
(Windows®) [solutions.brother.com/windows](http://solutions.brother.com/windows)

Choose your Connection Type:

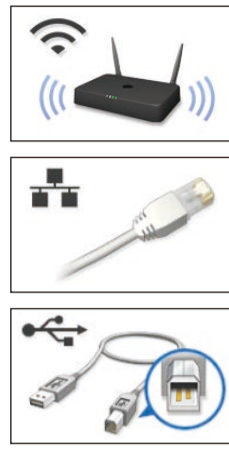

Follow the on-screen instructions to continue installation.

Follow the on-screen instructions to continue installation.

**Finish**

If using a wireless network connection:  
When the **Wireless Device Setup** screen appears, select **Setup without a USB cable (Recommended)**.

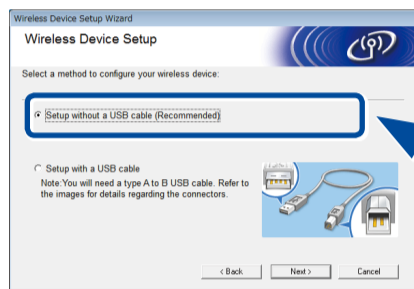

When instructed, go to your machine's LCD.

a. Press the **WiFi** icon on the LCD.



b. Press [WLAN Assistant].

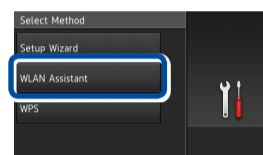

Follow the on-screen instructions to continue installation.

**Finish**

**NOTE:**

- When finished, restart your computer.
- If connection is unsuccessful, see **?** *Cannot set up your machine?* below.

**NOTE:**

If the LCD screen is blank, press **Wake Up** to wake up the device.

## WiFi Alternate wireless configuration method (Setup Wizard)

Restart your wireless access point/router.



Find your SSID: XXXXXXXX  
Network key: XXXX



Press **WiFi** > [Setup Wizard] > [Yes].

Select the SSID. Enter the Network key.

The LCD displays [Connected].

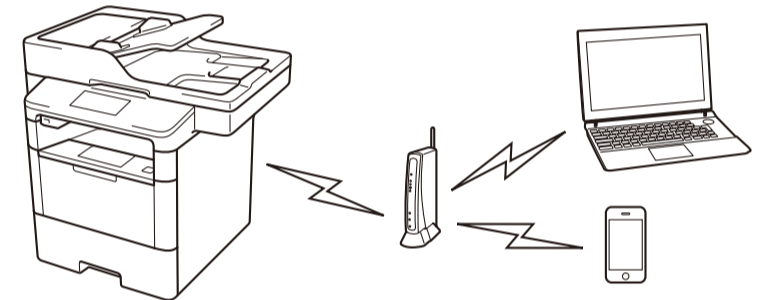

If you cannot find this information, ask your network administrator or wireless access point/router manufacturer.

**NOTE:**

For information on how to enter text, see the printed *Basic User's Guide*.

To use with your computer, follow Step 7 until the **Select Machine** screen appears, listing all machines in your network.

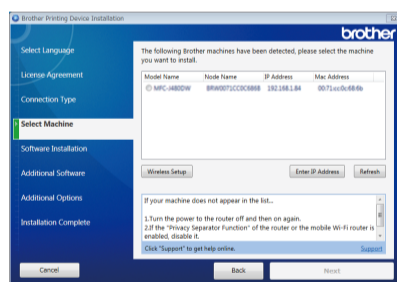

Select your machine.

Follow the on-screen instructions to continue installation.

**Finish**

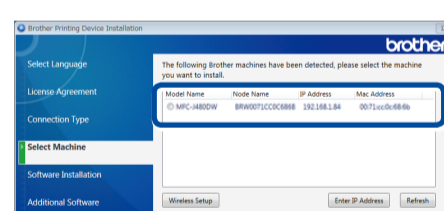

**NOTE:**

- When finished, restart your computer.
- If connection is unsuccessful, see **?** *Cannot set up your machine?* below.

To use with your mobile device, go to **Print and scan using your mobile device**.

## Print and scan using your mobile device

Before printing from your mobile device, your machine must be configured according to step 7 or **WiFi Alternate wireless configuration method (Setup Wizard)**.



Download "Brother iPrint&Scan" to start using your machine with mobile devices.

[solutions.brother.com/ips](http://solutions.brother.com/ips)



AirPrint is available for OS X and iOS users.

For more information, see the *AirPrint Guide* on your model's **Manuals** web page.

[solutions.brother.com/manuals](http://solutions.brother.com/manuals)

## ? Cannot set up your machine?

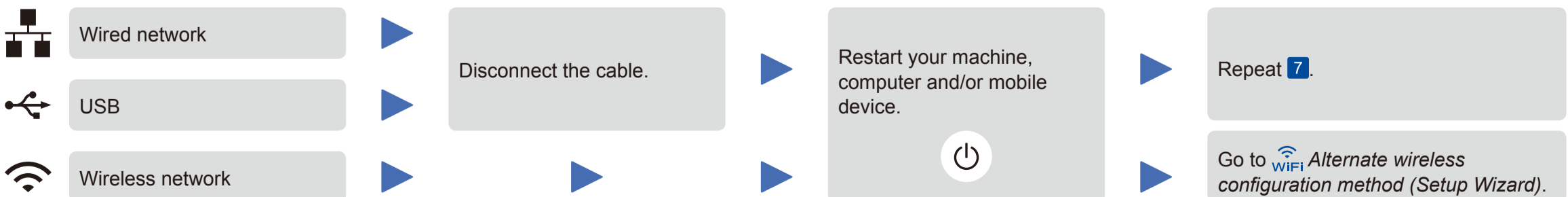

**NOTE:**

If you repeat these steps and connection is still unsuccessful, please visit the Brother Solutions Center at: <http://support.brother.com>.



Brother support website <http://support.brother.com>